

Fire & Safety Plan Sea Sailor

PRINCIPAL CHARACTERISTICS

| | |
|---------------------|---------|
| LENGTH OVER ALL | 68.80 m |
| LENGTH B.P. | 60.65 m |
| BREADTH | 12.00 m |
| BREADTH EXTREME | 12.60 m |
| DEPTH TO MAIN DECK | 5.90 m |
| DEPTH TO TWEEN DECK | 4.15 m |
| DRAUGHT MLD. | 4.10 m |

CLASS
DNV+1A1
SUPPLY VE88EL 8F FIFI 1

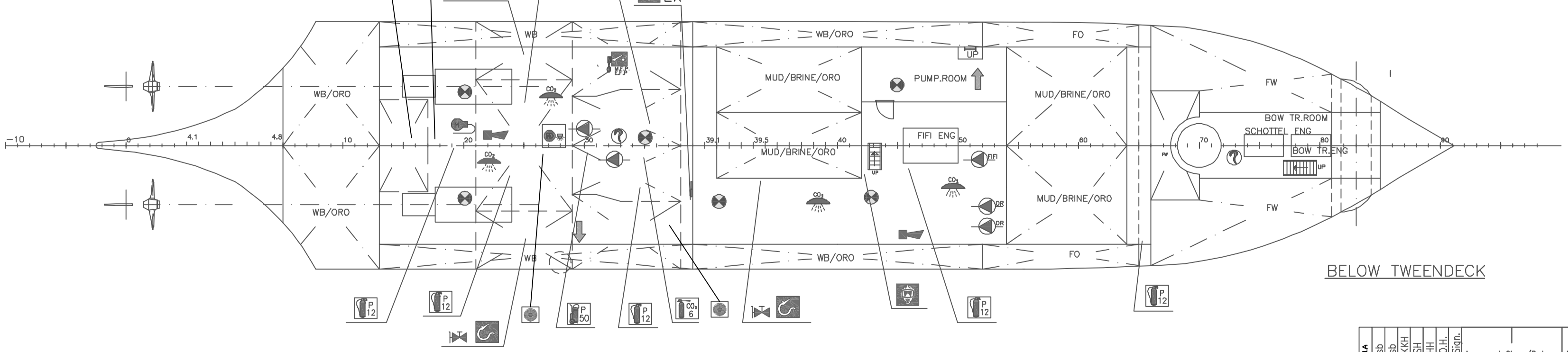
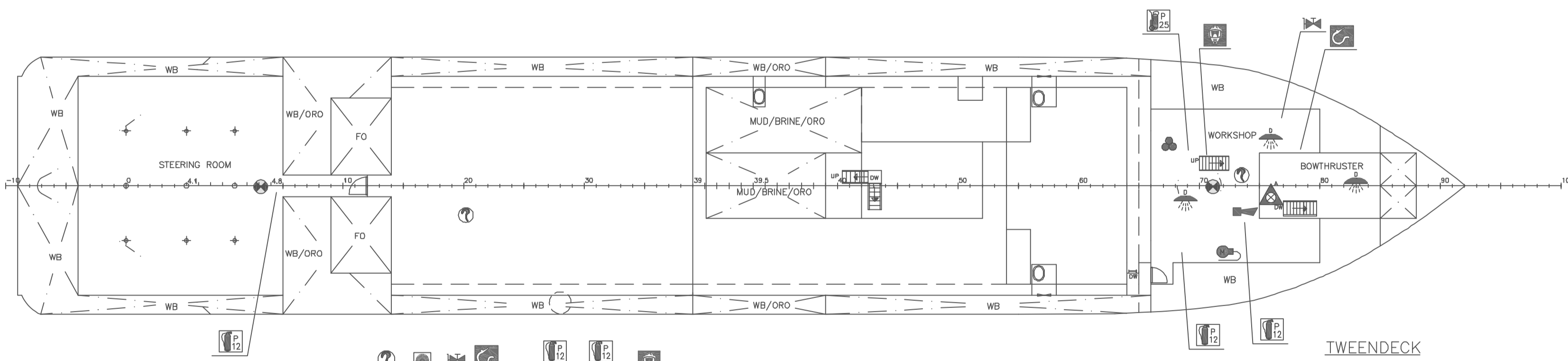
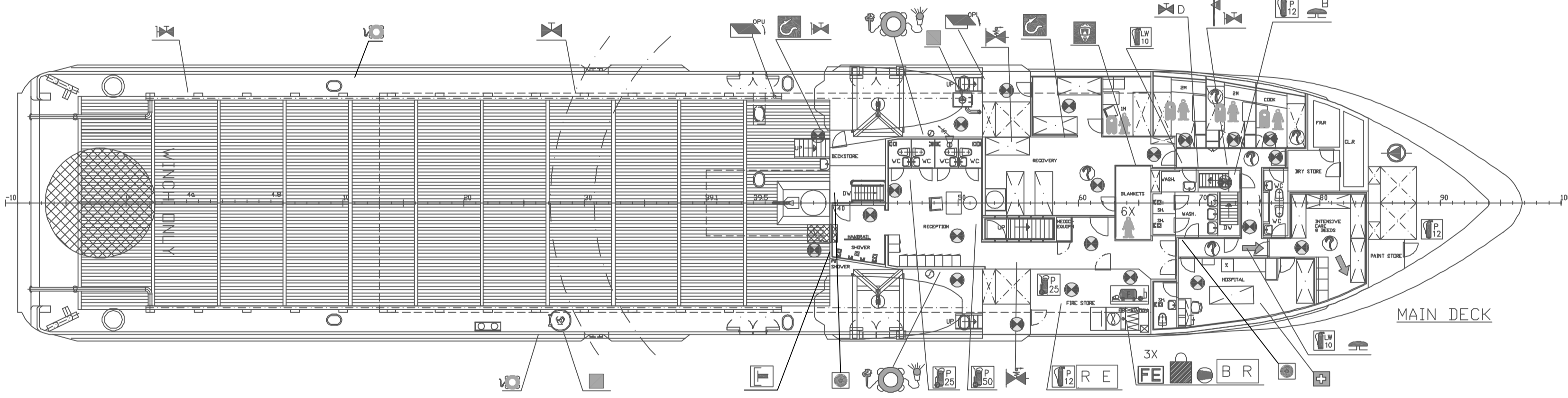
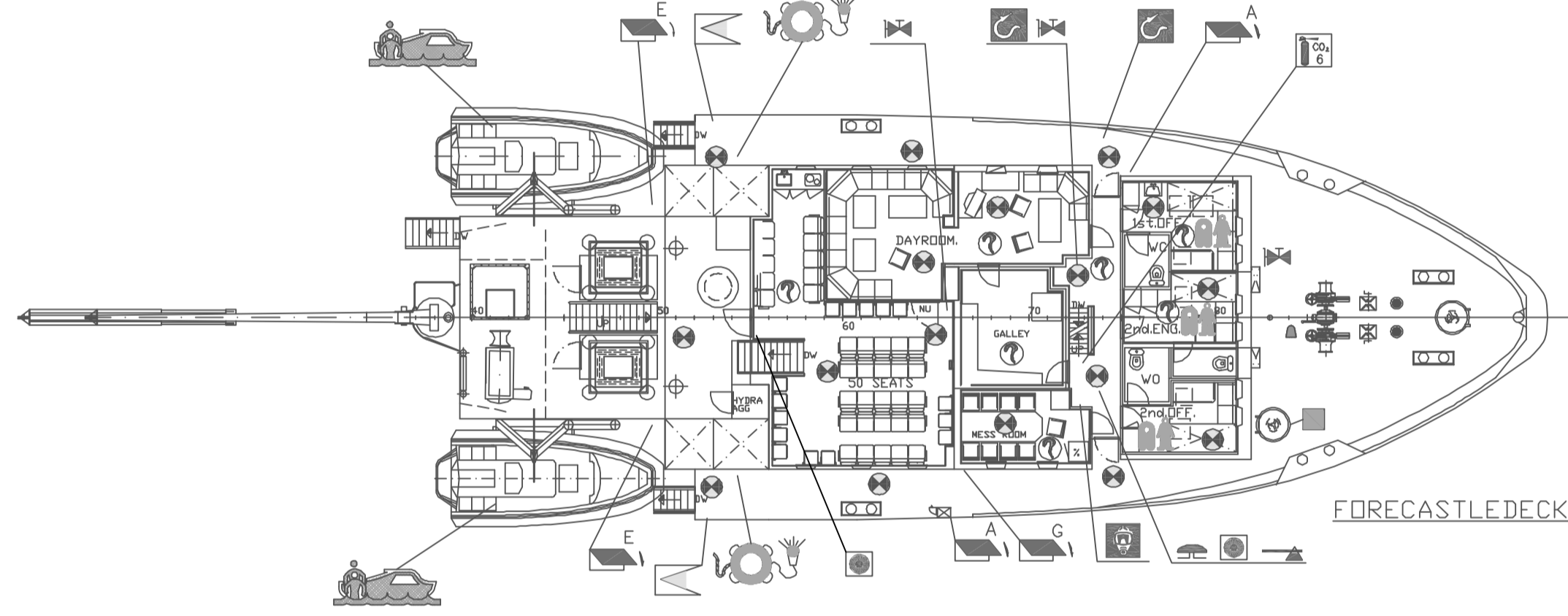
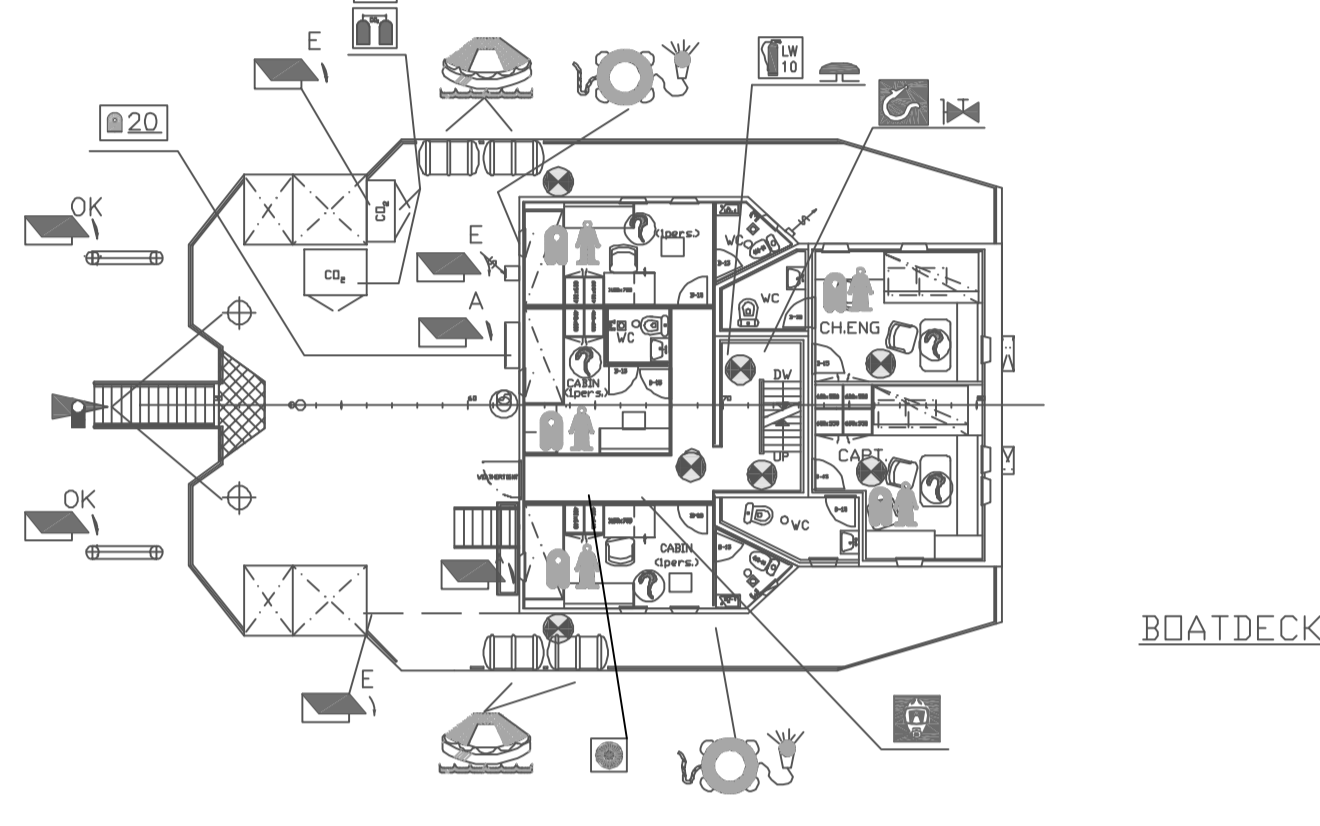
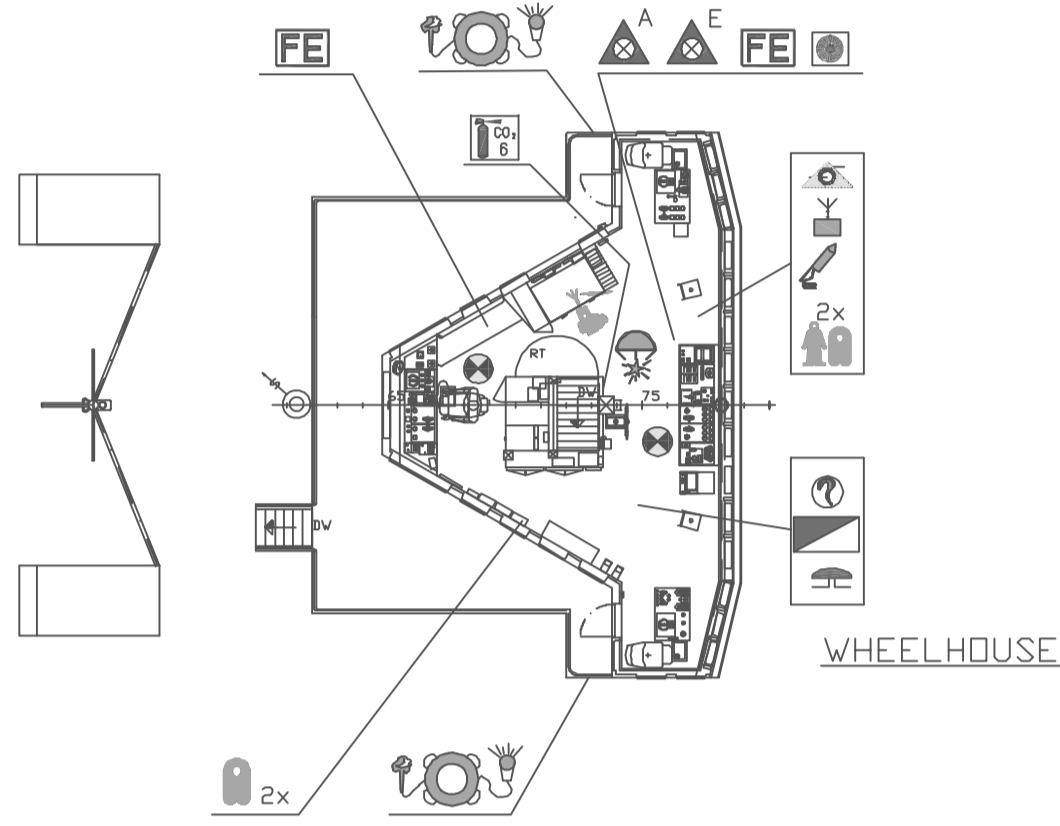
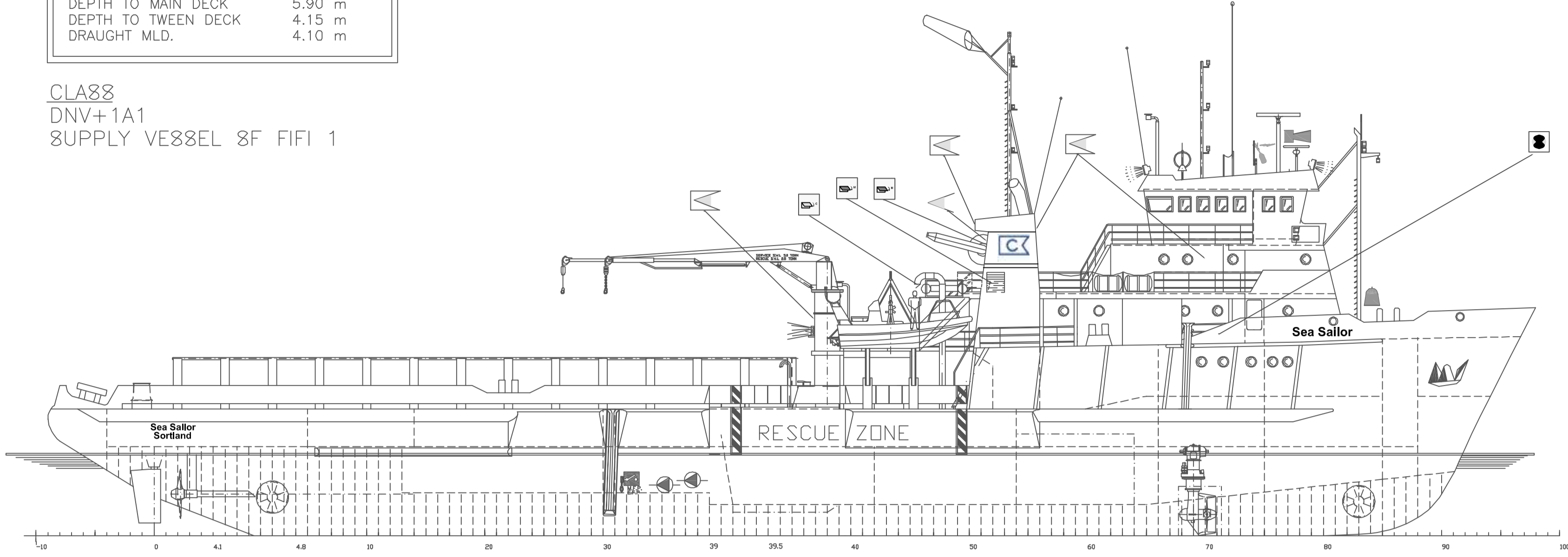

| SYM. | TOT | DESCRIPTION |
|------|-----|------------------------------------------------------------------------------------------------|
| AR | 2 | OVERRISLINGSPUMPE FIRE WASHDOWN PUMP |
| FIF | 1 | FIFI PUMPE FIFI PUMP |
| BR | 2 | BRANNPUMPE FIRE PUMP 100 m ³ / 90 m ³ V |
| NB | 1 | NØBBRANNPUMPE EMERGENCY FIRE PUMP 20 m ³ / 60 m ³ V |
| S | 1 | STOPPVENTIL BRANNEINGSEKSJON STOP VALVE FIRE MAIN SECTION |
| HV | 1 | HØVEDVENTIL TIL VANNSPRINKLER MAIN VALVE WATER SPRAY SYSTEM |
| D | 11 | BRANNHYDRANT FIRE HYDRANT |
| OS | 1 | OVERRISLING WATER SPRAY SYSTEM 147 m ³ /10 |
| IS | 1 | INTERNASJONAL LØNDTLØKBLING INTERNATIONAL SHORE CONNECTION |
| CO | 2 | CO ₂ -FLASKESENTRAL CO ₂ -BATTERY |
| UT | 3 | UTLØSSEKAP FOR CO ₂ RELEASING BOX FOR CO ₂ |
| TY | 3 | TYFEN CO ₂ ALARM TYPHEN CO ₂ ALARM |
| FJ | 2 | FJERNSTOPP AV BRENNØLJEPUMPER REMOTE STOP OF FUEL OIL PUMPS |
| AL | 3 | ALARMGIVER FOR CO ₂ ALARM DEVICE FOR CO ₂ |
| B | X | ALARMGIVER FOR BRANN- OG LIVBATALARM ALARM DEVICE FOR FIRE AND LIFEBOAT ALARM |
| X | X | TRYKKKNAPP FOR BRANNALARM FIRE ALARM PUSH-BUTTON |
| R | X | ROKVARSLER SMOKE DETECTORS |
| X | X | ØMRÅDE MED AUTMATISK BRANNVARSLER AREA WITH AUTMATISK SIGNALS FOR FIRE DETECTING |
| N | X | NØBLYS EMERGENCY LIGHT |
| FL | 1 | NØBLDLYS EMERGENCY FLOODLIGHT |
| FL | 1 | FLDMLYS FLOODLIGHT |
| SK | 1 | SKUM POST FOAM POST |
| S | 1 | START/STOPP BRANNPUMPER START/STOP OF FIRE PUMPS |
| FJ | 1 | FJERNSTENGING AV BRENNØLJEPUMPER REMOTE STOP OF FUEL OIL PUMPS |
| A | 1 | AUTMATISK BRANNALARMSENTRAL AUTOMATIC FIRE ALARM CENTRAL PANEL |
| V | 1 | VANNKANON VANN TYPE EXTINGUISHING GUN |
| Ø | 3 | ØMRÅDE MED CO ₂ -LØKING SPACE PROTECTED BY CO ₂ |
| Ø | 3 | VANNAPPARAT, BERBART WATER EXTINGUISHER, PORTABLE 10 L |
| Ø | 3 | CO ₂ -APPARAT, BERBART CO ₂ EXTINGUISHER, PORTABLE 6 KG |
| Ø | 13 | PULVERAPPARAT POWDER EXTINGUISHER 12 KG |
| Ø | 3 | PULVERAPPARAT, TRANSPORTABELT POWDER EXTINGUISHER, TRANSPORTABLE 25 KG |
| Ø | 2 | PULVERAPPARAT, TRANSPORTABELT POWDER EXTINGUISHER, TRANSPORTABLE 50 KG |
| Ø | X | ØMRÅDE MED VANN SPINKLER AREA PROTECTED WITH WATER SPRAY SYSTEM |
| Ø | XX | RESERVEVLÅDNER FOR BRANNSLØKINGAPPARATER REFILLS FOR FIRE-FIGHTING APPARATUS |
| H | 1 | BRANNSLANGE MED KOMBINERT STRÅLERØR/TÅKESPREIDER FIRE HOSE WITH COMBINED JET AND FOG NOZZLE |
| A | 2 | BRANNØKS FIRE AXE |
| FE | 5 | BRANNMANNUTSTYR FIREMAN'S EQUIPMENT |
| B | 1 | DRILL MED SKJØYTELEDNING DRILL WITH CABLE |
| A | 1 | TRYKKLUFTKOMPRRESSOR AIR COMPRESSOR |
| M | 2 | MANN ØVERBERD BAT DAVIT (SWL 3000 KG) SEABEAR FRAC ONLY |
| L | 4 | ØPPBLASBAR FLÅTE INFLATABLE LIFE RAFT 4 x 20 MANN |
| S | 3 | SVØMMEDRÅKT SUITS FOR SURFACE SWIMMERS |
| L | 4 | LIVBØYE MED LYS OG RØYK LIFEJUDY WITH LIGHT AND SMOKE SIGNAL |
| L | 4 | LIVBØYE MED LYS OG LINE LIFEJUDY WITH LIGHT AND LINE |
| L | 2 | LIVBØYE MED LINE LIFEJUDY WITH LINE |
| E | 6 | EVAKUERINGS PUSTEMASKE EMERGENCY ESCAPE BREATHING DEVICE |
| R | 14 | REDDINGSVEST LIFE JACKET |
| L | 1 | LINEKASTER APPARAT LINE-THROWING APPLIANCE |
| B | 1 | SKAP/KASSE MED REDDINGSVESTER BOX/CABINET WITH LIFE JACKETS |
| R | 20 | REDDINGSØKST SURVIVAL SUIT |
| V | 1 | VHF NØDKOMMUNIKASJONSSETT, FLYFREKVENNS VHF EMERGENCY TRANSCIVER, HERMOBILE |
| N | 1 | NØDPEILESENDER, FRI FLYT EMERGENCY BEACON "FLDAT FREE" |
| R | 3 | BERBART UHF RADIO EQUIPMENT UHF |
| N | 1 | NØDSIGNALER DISTRESS SIGNAL |
| H | 1 | SYKEMED W/MEDISIN SKRIN HOSPITAL W/MEDICIN LOCKER |
| X | X | NØDDØPPGANG EMERGENCY EXIT |
| X | X | FLUKTRETNING DIRECTION OF ESCAPE |
| FJ | 2 | FJERNSTENGING AV BRENNØLJETANKER REMOTE CLOSING OF FUEL OIL TANKS |
| X | X | FJERNSTOPP AV VENTILASJONSVIFTER REMOTE STOP OF VENTILATOR FANS |
| X | X | MANUELL STENGING AV VENTILASJON MANUAL CLOSING OF VENT OPENINGS |
| T | 1 | TYFEN TYPHEN |
| TR | 1 | TRYKKKNAPP FOR LIVBATALARM PUSH-BUTTON FOR LIFEBOAT ALARM |
| S | 1 | SKIPSKLOKKE SHIP'S BELL |
| K | 10 | KANNER MED SKUMVÆSKE CANS WITH FDM FLUIDS 200 L |
| X | X | BRANN OG SIKKERHETSPLAN FIRE AND SAFETY PLAN |

| | |
|----|-----------------------------------------------------------------------------------------------------------------------------------------------------------------------------------------------------------------------------------------------------------------------------------------------------------------------------------------------------------------------------------------------------------------------------------------------------------------------------------------------------------------------------------------------------------------|
| BR | BRANNVERN UTSTYR HELIKOPTERDEKK FIRE-EXTINGUISHING EQUIPMENT |
| | 1 x 45 KG PULVERAPPARAT 1 x 45 KG POWDER APPARATUS 10 x 200 l SKUMVÆSKE 10 x 200 l FDM CONCENTRATE 1 TRANSPORTABELT SKUMMER 1 PORTABEL FDM APPLICATOR 1 BATSÅKES 1 BØY HØK 1 BRANNØKS 1 FIRE AXE 1 KNIVER 1 KNIVES 1 BREKKEKERN 1 CROWBAR 1 AVBITTER 1 PINCERS 1 TEFER, BRANNØKS 3 x 3 M 1 BLANKETS, FIRE RESISTANT 3 x 3 M 1 BRANNDRÅKTER + HANSKER, HJELM OG STØVLER 1 FIREMAN'S SUITS + GLOVES, HELMET AND BOOTS |
| RE | REDDINGSUTSTYR V/REDDINGSOPERASJON RESCUE EQUIPMENT V/RESCUE OPERATION |
| | 2 REDDINGSNETT 2 LIFENET 2 LIVLINER W/KARABINØKKER 4 LIFELINES W/SNAPHOOKS 4 SIKKERHETSBELTE, W/LINE OG KROK 4 SAFETY BELT W/REFE AND HOOK 2 VANDREVIRE 2 WANDER WIRE 1 DIVERSLADDER 1 DIVING LADDER 4 BATSÅKES 4 BOAT HOOK 1 REDDINGSKORB 1 RESCUE BASKET 26 REDDINGSVESTER 26 LIFE JACKETS 4 ARBEIDSDRÅKTER 4 WORKING SUITS 3 ØTSTYR FOR ØVERFLATESØMMERE 3 EQUIPMENT FOR SURFACE SWIMMERS |
| FE | BRANNMANNUTSTYR FIREMAN'S EQUIPMENT |
| | SMOKE BREATHING APP. W/2x6L/300 BAR SPARE BOTTLES ROKVARSLER APP. W/2x6L/300 BAR RESERVE KANNE FIRE PROTECTIVE CLOTHES W/GLOVES BRANNSKYTTETENNE KLÆR W/HANSKER BOOTS AND FIRE HELMET STØVLER OG BRANNSJELM SAFETY LAMP SIKKERHETS LAMPE FIRE AXE BRANN ØKS SAFETY LINE W/SNAPHOOK AND SAFETY BELT SIKKERHETS LINE W/KARABINØK OG SIKKERHETS BELTE KANNER MED SKUMVÆSKE CANS WITH FDM FLUIDS SKUMMER/GRAV, TRANSPORTABELT TRANSPORTABLE FDM EXTINGUISHING SET SIKKERHETSPLAN Plassering SAFETY PLAN LOCATION |

EVAKUERINGS PUSTEMASKE INCLUDE SPARE
EMERGENCY ESCAPE BREATHING DEVICE

| Rev. | From | Description | Approved/Date | Approved/Date | Appr. Authorities/Date | Approved/Date | Approved/Date | Checked V&S/Date |
|------|-----------------|-----------------|---------------|---------------|------------------------|---------------|---------------|------------------|
| 1 | STAND-BY | STAND-BY | | | | | | |
| 2 | REDDERI: | REDDERI: | | | | | | |
| 3 | CHRISHIP AS | CHRISHIP AS | | | | | | |
| 4 | Sortland | Sortland | | | | | | |
| 5 | Scale | Scale | | | | | | |
| 6 | Date | Date | | | | | | |
| 7 | SFI | SFI | | | | | | |
| 8 | Format | Format | | | | | | |
| 9 | Ready for NC/SO | Ready for NC/SO | | | | | | |
| 10 | Project No. | Project No. | | | | | | |
| 11 | Rev. | Rev. | | | | | | |
| 12 | Drawing No. | Drawing No. | | | | | | |
| 13 | 811 IK12 | 811 IK12 | | | | | | |
| 14 | Sheet | Sheet | | | | | | |
| 15 | 1/1 | 1/1 | | | | | | |

VIK-SANDVIK
Member of the VIK-Sandvik Group

S419 FITJAR, NORWAY
80
FAX +47 53 45 70 01
VSN@vik-sandvik.com